

INTERNATIONAL
ASSOCIATION OF CERTIFIED
HOME INSPECTORS



HOME ENERGY
INSPECTION

Air Leaks and Air Sealing

A Homeowner's Guide

InterNACHI, the International Association of Certified Home Inspectors, recognizes the enormous potential that exists for improving the energy efficiency, safety, and comfort of existing American homes. This guide describes approaches for homeowners, home inspectors, and qualified contractors working on existing homes. This guide will help homeowners identify ways to make their homes more comfortable, more energy efficient, and healthier to live in. It also identifies the steps to take, with the help of an InterNACHI-Certified Home Energy Inspector and qualified home performance contractor, to seal unwanted air leaks while ensuring healthy levels of ventilation and avoiding sources of indoor air pollution.

This guide is based on the research and demonstration projects conducted by the U.S. Department of Energy's Building America and Home Performance with ENERGY STAR sponsored by the U.S. Environmental Protection Agency and the U.S. Department of Energy.

Table of Contents

Preface	3
Acknowledgements	4
New Code Air Sealing Requirements	7
An Air Sealing Checklist.....	8
1. Air Barrier and Thermal Barrier Alignment.....	9
2. Attic Air Sealing	10
3. Attic Kneewalls.....	11
4. Duct Shaft/Piping Shaft and Penetrations	12
5. Dropped Ceiling/Soffit	13
6. Staircase Framing at Exterior Wall/Attic.....	14
7. Porch Roof.....	15
8. Flue or Chimney Shaft	16
9. Attic Access/Pull-Down Stairs	17
10. Recessed Lighting	18
11. Ducts	19
12. Whole-House Fan.....	20
13. Exterior Walls	21
14. Fireplace Wall	22
15. Garage/Living Space Walls	23
17. Rim Joists, Sill Plate, Foundation and Floor.....	25
18. Windows and Doors.....	27
Homeowner Tips: Insulation and Sealing Air Leaks.....	29
Adding Insulation	31
Quick Tips: Insulation.....	34
Quick Tips: Sealing Air Leaks.....	35
Sources of Air Leaks in Your Home	37

Preface

InterNACHI, the International Association of Certified Home Inspectors (www.nachi.org), recognizes the enormous potential that exists for increasing the energy efficiency, safety and comfort of existing American homes. This guide describes approaches for homeowners, inspectors and contractors working to improve existing homes. It will help homeowners identify ways to make their homes more comfortable, more energy-efficient, and healthier to live in. It also identifies the steps they can take, with the help of an InterNACHI-Certified Home Energy Inspector and a qualified home performance contractor, to seal unwanted air leaks while ensuring healthy levels of ventilation, as well as avoiding sources of indoor air pollution.

Inspectors can use this manual to explain the value of these air sealing measures to their customers. Studies show that the measures described in this guide can typically achieve whole-house energy savings of 10% to 20% over pre-retrofit energy usage. In older homes and homes with greater levels of air leaks, savings may be much higher. These practices are based on the results of research and demonstration projects conducted by the U.S. Department of Energy's Building America, and Home Performance with ENERGY STAR, sponsored by the U.S. Environmental Protection Agency and the DOE. Home Performance with ENERGY STAR offers a comprehensive, whole-house approach to improving the energy efficiency and comfort of existing homes and requires a test-in/test-out to test combustion products (www.energystar.gov/homeperformance).

Consult a Contractor

The purpose of this publication is to provide accurate and useful information with regard to saving home energy. Before acting upon the information provided in this book, consult a qualified contractor. Neither the publisher nor author is engaged in rendering legal, accounting, construction, repair or other professional service. If legal advice or other expert assistance is needed, the services of a professional should be sought. Neither the publisher nor author is liable or responsible in any way for the specific use of any information in this book.

WARNING: Home maintenance and home improvement involves risk of bodily injury and damage to personal property. Do not perform repairs or corrections by yourself. Before performing any maintenance or work, hire an appropriately qualified contractor. Do not act upon the information provided in this book without consulting an expert or qualified contractor. This publication does not come with a warranty of any kind.

Acknowledgements

The content of this guide is derived from public information provided by the United States government and its Department of Energy.

InterNACHI, nor any of its employees, makes any warranty, express or implied, or assumes any legal liability or responsibility for the accuracy, completeness or usefulness of any information, apparatus, product or process disclosed, or represents that its use would not infringe privately owned rights. Reference herein to any specific commercial product, process or service by trade name, trademark, manufacturer, or otherwise does not necessarily constitute or imply its endorsement, recommendation or favoring by InterNACHI. The views and opinions of authors expressed herein do not necessarily state or reflect those of InterNACHI.

SOURCES:

- Lawrence Berkeley National Laboratory, The Potential for Reducing Urban Air Temperatures and Energy Consumption Through Vegetative Cooling.
- Energystar.gov, Water Heater, Whole-Home Gas Tankless, energystar.gov.
- 2010 Buildings Energy Data Book, buildings databook.eren.doe.gov.
- U.S. Department of Transportation press release March 2, 2011: Nation's Highway Traffic Reaches Highest Level Since 2007.
- U.S. Energy Information Administration, U.S. Primary Energy Flow by Source and Sector, 2009.

Air Leaks



Imagine opening a window in your house and leaving it that way 24 hours a day, all year long.

Buckets of Quarters

On balmy spring days, the breeze wouldn't be so bad. But in the freezing cold of winter and the sticky heat of summer, with the furnace or air conditioner on, smart homeowners would recognize that they might as well be throwing buckets of quarters out that open window to pay for the escaping heated or cooled air.

Saving 10% to 20%

Air leaks in most existing homes add up to an open window in your home. Air sealing is one of the least expensive and most cost-effective measures you can take to improve your home's comfort and energy efficiency. By sealing uncontrolled air leaks, you can expect to see savings of 10% to 20% on your heating and cooling bills, and even more if you have an older or especially leaky house. But before you grab your caulk gun, there are some things you should consider.

Other Options

Many older homes lack proper ventilation, so they depend on those cracks and leaks to let in air, especially when fuel-burning appliances are operating inside the home. Without ventilation, carbon monoxide and air pollutants from cleaning chemicals, combustion appliances, and off-gassing household products can build up, creating an unhealthy and even dangerous environment in the home. Opening windows is one way to ventilate, but there are times when opening the windows is not practical, such as when it's too hot or too cold outside. Fortunately, there are other options for bringing fresh air into your home. A certified contractor can help you get all the energy savings and comfort possible from a well-sealed home, along with the safety of proper ventilation.



Your house is a system, and all its components work together. Adding insulation and sealing air leaks can improve its energy efficiency and durability, as well as increase your family's comfort. However, every change you make to the building's envelope (its walls, floors and ceilings) and components will affect how well the home works to keep out the elements and keep your family safe and comfortable. Tightening the building envelope without providing appropriate ventilation can cause pressure imbalances or negative pressure in the house. This negative pressure can set up unwanted conditions for back-drafting of fireplaces and fuel-burning (combustion) appliances and draw pollutants into the home. A trained contractor understands how the home's systems work together to keep your house operating as it should.

This guide gives homeowners tips on how to get their homes inspected for energy efficiency by an InterNACHI-Certified Home Energy Inspector (www.inspectorseek.com), how to pinpoint the location of the biggest air leaks and how to fix them, what the potential health and durability concerns are, and how your contractor can handle these concerns—in short, what you need to know in order to proceed with confidence for creating a more comfortable, energy-efficient and healthy home for your family.

If you are a home inspector, share this guide with your clients so that they can understand the process they can follow to make their homes more comfortable, durable and energy-efficient.

Air Sealing vs. Insulation

Why do I need to air seal?
I thought all I needed to do was add more insulation.

Insulation is like a fuzzy wool sweater on a winter day. It will certainly keep you warm if the air is calm.

But if the wind picks up, you are going to need a windbreaker to keep the breeze from carrying away the heat. Air sealing is like adding the windbreaker. It keeps the conditioned air where it belongs.

New Code Air Sealing Requirements

The 2009 International Energy Conservation Code (IECC) and the 2009 International Residential Code (IRC) have several new mandatory requirements for air sealing in new construction and additions. These codes apply to new construction where adopted by local jurisdictions. In general, these requirements do not apply to retrofit projects (or energy improvements on existing homes) unless the project adds living space to the building or changes the building's energy load. The existing, unaltered portions of the structure are not required to comply with all of the codes of the 2009 IECC or IRC. However, it is a good idea to implement these requirements in existing portions of your home wherever they are applicable and as your budget allows, or when health and safety concerns make them necessary.

The mandatory requirements regarding new buildings are summarized in this section excerpted from the IECC's Chapter 4, Section 402.4, "Air Leakage" (quoted verbatim). (Builders can refer to the IECC 2009's Chapter 4, "Residential," and the IRC 2009's Chapter 11, "Energy Efficiency," for more details.)



Here are the IECC's requirements:

"The building thermal envelope shall be durably sealed to limit infiltration. The sealing methods between dissimilar materials shall allow for differential expansion and contraction.

The following shall be caulked, gasketed, weather-stripped or otherwise sealed with an air barrier material, suitable film, or solid material:

1. all joints, seams and penetrations,
2. site-built windows, doors, and skylights,
3. openings between window and door assemblies and their respective jambs and framing,
4. utility penetrations,
5. dropped ceilings or chases adjacent to the thermal envelope,
6. knee walls,
7. walls and ceilings separating a garage from conditioned spaces,
8. behind tubs and showers on exterior walls,
9. common walls between dwelling units,
10. attic access openings,
11. rim joist junctions, [and]
12. other sources of infiltration."

An Air Sealing Checklist

This section provides descriptions of the areas of the home most likely to have air leakage, when those problems should be addressed, the potential durability and health concerns related to those problems, and sources for more information. Additional information on how to identify and fix these problems, as well as other building science facts and data, can be found in the Building America Best Practices guides produced by the U.S. DOE and are available for free download at www.buildingamerica.gov. Work with your contractor to determine which of these measures are most needed and most cost-effective.

Common air sealing trouble spots are shown on the graphic below and listed on the following page. Research has identified 19 key areas where air sealing can improve a home's energy efficiency, comfort, and building durability. The information in this guide can help you find a certified home performance contractor and work with him or her to identify problem areas, prioritize projects with safety in mind, and start sealing the air leaks in your home for cost-effective energy savings.

Air Sealing Trouble Spots

- 1 Air Barrier and Thermal Barrier Alignment
- 2 Attic Air Sealing
- 3 Attic Kneewalls
- 4 Shaft for Piping or Ducts
- 5 Dropped Ceiling/Soffit
- 6 Staircase Framing at Exterior Wall
- 7 Porch Roof
- 8 Flue or Chimney Shaft
- 9 Attic Access
- 10 Recessed Lighting
- 11 Ducts
- 12 Whole-House Fan
- 13 Exterior Wall Penetrations
- 14 Fireplace Wall
- 15 Garage/Living Space Walls
- 16 Cantilevered Floor
- 17 Rim Joists, Sill Plate, Foundation, Floor
- 18 Windows & Doors
- 19 Common Walls Between Attached Dwelling Units

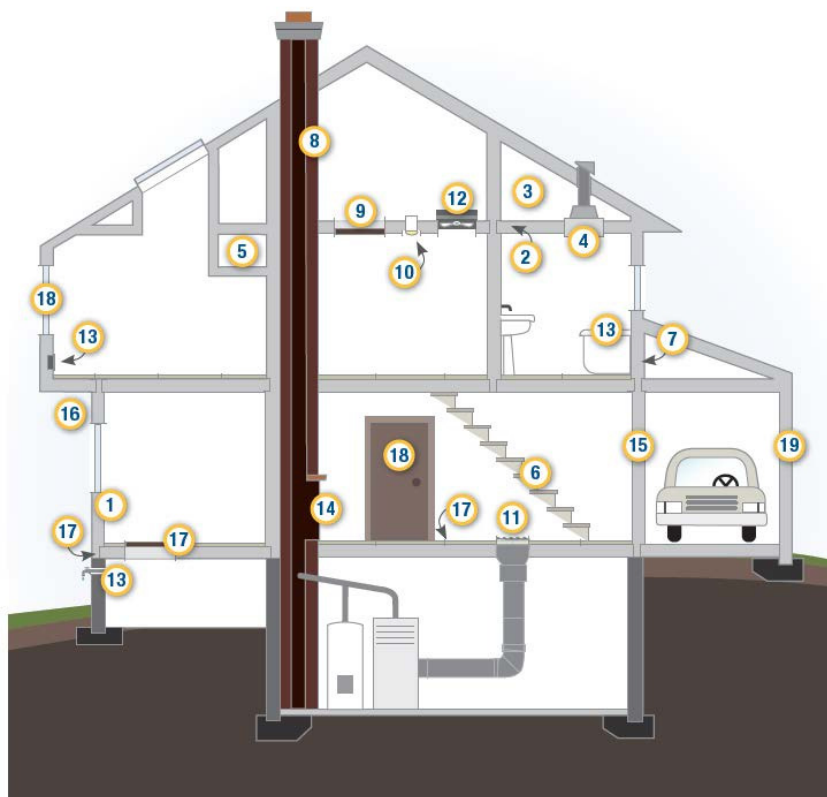

1. Air Barrier and Thermal Barrier Alignment

The air barrier is in alignment with (or touching) the thermal barrier (insulation).

Convective loops can form in wall cavities if there are gaps between the insulation and the air barrier. Convective loops—characterized by air movement within the wall cavities created by temperature differences—will cause cold air to fall and hot air to rise. This air movement reduces the effectiveness of the insulation and can pull in outside air and cause moisture problems. Arches, soffits, chases, and other design features create an uneven air barrier (or drywall plane) that is difficult to thoroughly insulate. Expect your contractor to inspect these areas visually or with an infrared camera to make sure that batts or blown insulation completely fill the wall cavities.

Durability & Health

Convective loops in walls can pull in pollen, dust and moisture. Walls that are not well-insulated can provide a cold surface in wall cavities where warm indoor air can condense in the winter and warm outdoor air can condense in the summer, encouraging mold growth within walls.

Thermal and air-barrier alignment is not an issue with certain insulation materials, such as spray foam and rigid foamboard, which create an air barrier as well as a thermal barrier, as long as they form a continuous air barrier from top to bottom and from side to side. Spray foams should be sprayed to a consistent minimum depth across the area to be sealed and insulated. Rigid foamboard that serves as the air and thermal barrier should be taped at the seams with housewrap tape and glued with caulk at the edges to the wall framing, sill plate or top plate. Blown cellulose and blown or batt fiberglass insulation will not stop air flow.



Above left: Cut fiberglass batt insulation to fit around electrical boxes, wiring and pipes that run through the walls. Compressions like the one shown above can ruin the batt's thermal alignment with the wall, which decreases its effectiveness.

Above right: Install batts to fit smoothly and to completely fill wall and ceiling cavities. Here, fiberglass batts completely fill the joists of the basement ceiling.

2. Attic Air Sealing

Top plates and wall-to-ceiling connections are sealed.

Good air sealing and a continuous air barrier between the attic and the home's conditioned (or living) space are important not only to save energy and reduce fuel bills, but also to prevent moisture problems in the attic. Sealing holes in the attic makes chimneys and flues work better because a leaky attic ceiling acts like a chimney and will compete with the real chimney for air. Air sealing a leaky attic ceiling can also reduce the house's stack effect.

On the inside of the home, the ceiling drywall can serve as an air barrier. Visible cracks at the seam of the wall and ceiling can be taped, mudded and painted or filled with paintable caulk, such as silicone latex. Your contractor can determine where the leaks are with an infrared camera, by feeling for air flow, and by inspecting the attic insulation. Dirty insulation is an indication that air is flowing through the insulation and pulling dust with it.

Your contractor may pull back or scoop out the insulation to apply caulk, spray foam, or other sealant where the walls meet the attic floor. Other places in the attic that often are big sources of air leaks are soffits (dropped-ceiling areas, duct chases, plumbing chase), behind or under attic kneewalls, around recessed can lights, around flue pipes, around ducts, and at attic hatches.

Durability & Health

Heat moves from high-temperature regions to low-temperature regions. The warmer the air, the more water vapor it can carry with it. If warm, moist air gets into a cold attic through leaks in the home's thermal envelope, it can condense on rafters and other solid surfaces, which may lead to water damage and mold growth.

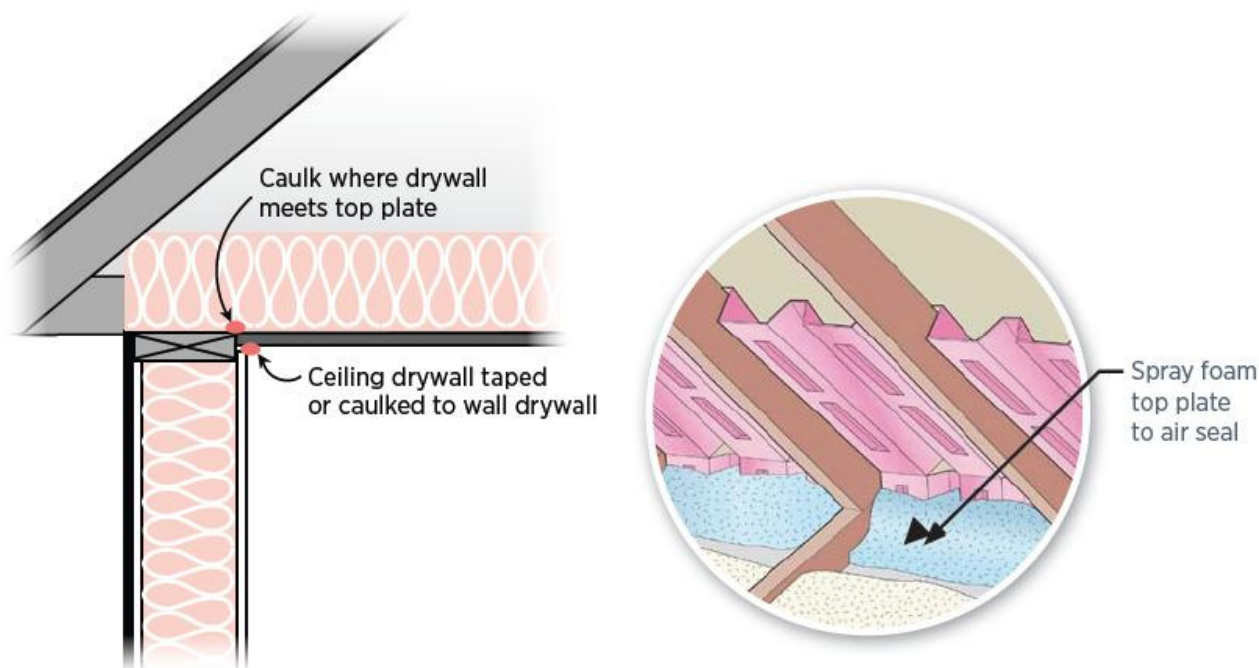

*Above left: Seal the wall's drywall to the top plate and ceiling drywall.
Above right: Seal the drywall at the top plate area.*

3. Attic Kneewalls

Air barrier is installed at the insulated boundary, such as the kneewall transition or roof, as appropriate.

Kneewalls, which are the sidewalls of finished rooms in attics, are often leaky and uninsulated. Your contractor can insulate and air seal these walls in one step by covering them from the attic side with sealed rigid foamboard insulation. Your contractor can plug the open cavities between joists beneath the kneewall with plastic bags filled with insulation or with pieces of rigid foamboard. Another option is to apply rigid foamboard to the underside of the rafters along the sloped roof line and air seal at the top of the kneewall and the top of the sidewall, which provides the benefit of both insulating the kneewall and providing insulated attic storage space.

Doors cut into kneewalls should also be insulated and air sealed by attaching rigid foamboard to the attic side of the door and using a latch that pulls the door tightly to a weatherstripped frame.

Durability & Health

If warm, moist air gets into a cold attic through leaks in the home's thermal envelope, it can condense on rafters and other solid surfaces, which may lead to water damage and mold growth.

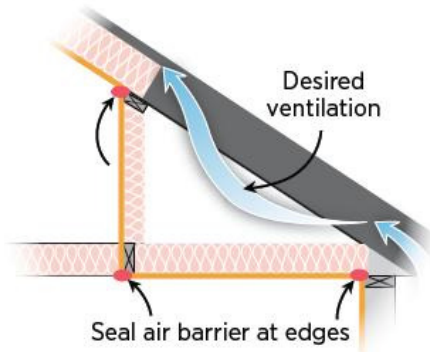

Insulate and air seal the kneewall itself, as shown, or along the roof line.



Air seal floor joist cavities under kneewalls by filling them with fiberglass batts that are rolled and stuffed into plastic bags (as shown here), or use rigid foamboard, OSB, or other air barrier board cut to fit and sealed at their edges with caulk.

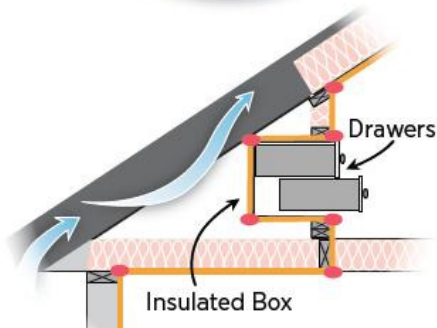

Build an airtight, insulated box around any drawers and closets built into attic kneewalls that extend into uninsulated attic space. Insulate along the air barrier (shown in yellow) or along the roof line with rigid foamboard.

4. Duct Shaft/Piping Shaft and Penetrations

Openings from attic to conditioned space are sealed.

Any chases, shafts and building cavities that contain piping or wiring can serve as links between conditioned and unconditioned space. Your contractor can inspect these areas and close the gaps with caulk, spray foam, and blocking material, such as pieces of rigid foamboard, plywood, or oriented strand board cut to fit and sealed in place with spray foam. Furnace flues require high temperature-rated sealing materials.

Durability & Health

HVAC, plumbing and wiring chases can bring conditioned air into attics, leading to condensation and mold problems. They can also connect crawlspaces and living spaces, bringing soil gases into the home.

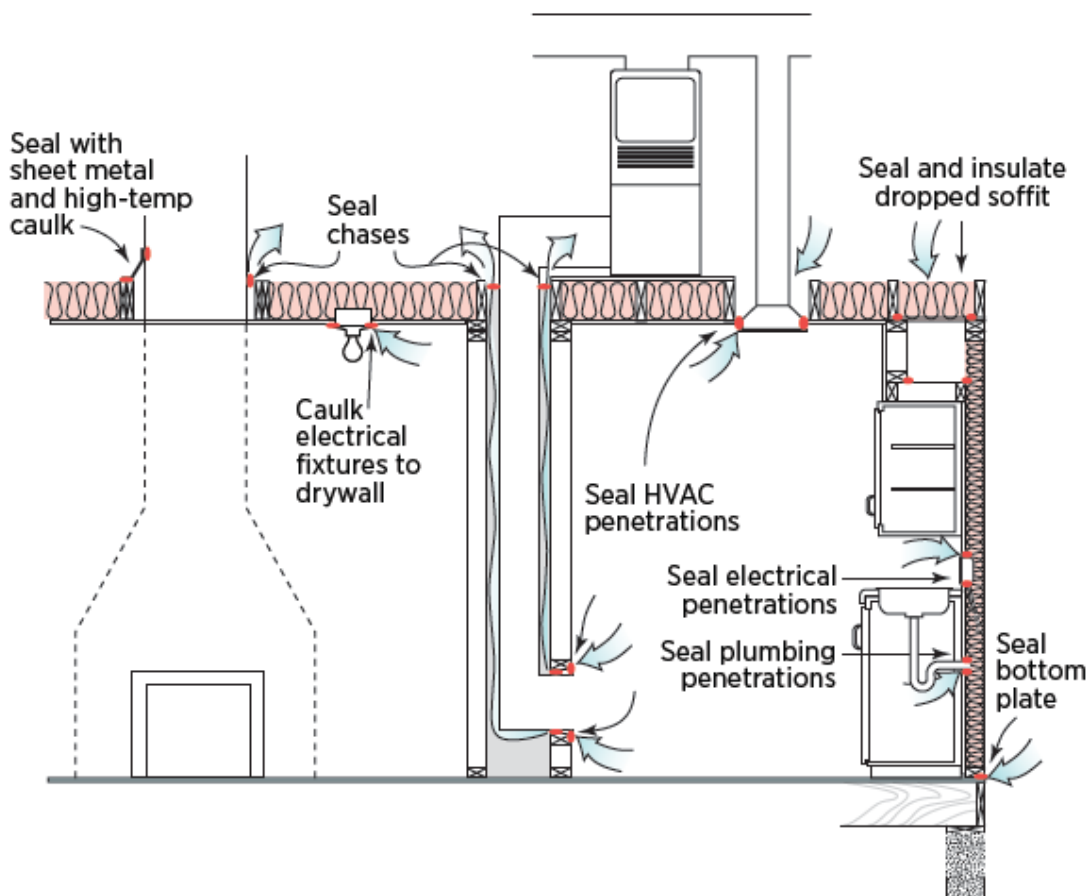

Above: Seal attic and wall penetrations associated with mechanical ventilation systems, electrical chase openings, and dropped soffits.

5. Dropped Ceiling/Soffit

Air barrier is fully aligned with insulation; all gaps are fully sealed.

Soffits (or dropped ceilings) located over kitchen cabinets and running along hallways and room ceilings as duct or piping chases are typical culprits for air leakage. Your contractor will push aside the attic insulation to see if an air barrier is in place over the dropped area. If none exists, the contractor will cover the area with a piece of rigid foamboard, sheet goods, or reflective foil insulation that is glued in place and sealed along all its edges with caulk or spray foam, then covered with attic insulation. If the soffit is on an exterior wall, sheet goods or rigid foamboard should be sealed along the exterior wall, as well. If the soffit contains recessed can lights, they should be rated for insulation contact and airtight (ICAT), or a dam should be built around them to prevent insulation contact.

Durability & Health

If warm, moist air gets into a cold attic through leaks in the home's thermal envelope, it can condense on solid surfaces, which may lead to water damage and mold growth.

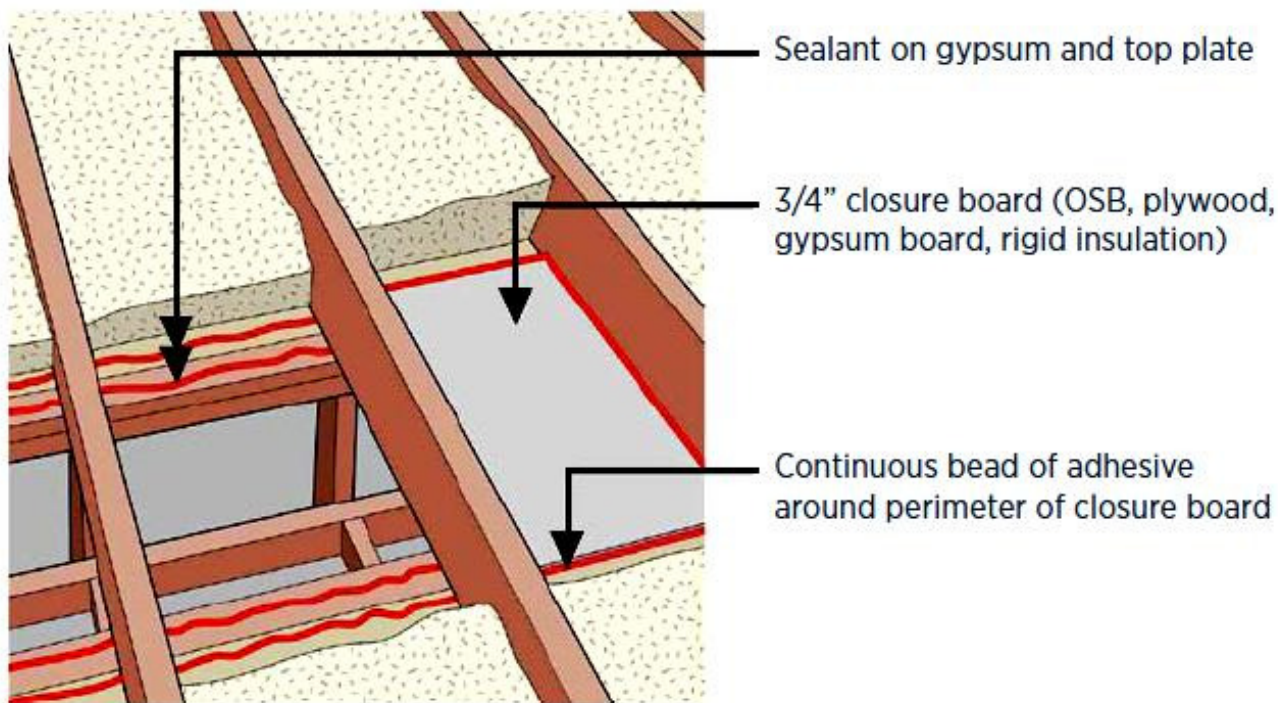

Pictured above:

Place a solid air barrier over soffits as follows:

1. pull back the existing insulation;
2. cover the area with air-barrier material (gypsum, plywood, OSB, rigid foamboard, etc.);
3. seal the edges with caulk; and
4. cover with insulation. (*Lstiburek 2010*)

6. Staircase Framing at Exterior Wall/Attic

Air barrier is fully aligned with insulation; all gaps are fully sealed.

If the area under the stairs is accessible, look to see if the inside wall is finished. If not, have your contractor insulate it, if needed, and cover it with a solid sheet product, such as drywall, plywood, oriented strand board, or rigid foamboard insulation. Then, your contractor can caulk the edges and tape the seams to form an airtight barrier. Stairs should be caulked where they meet the wall.

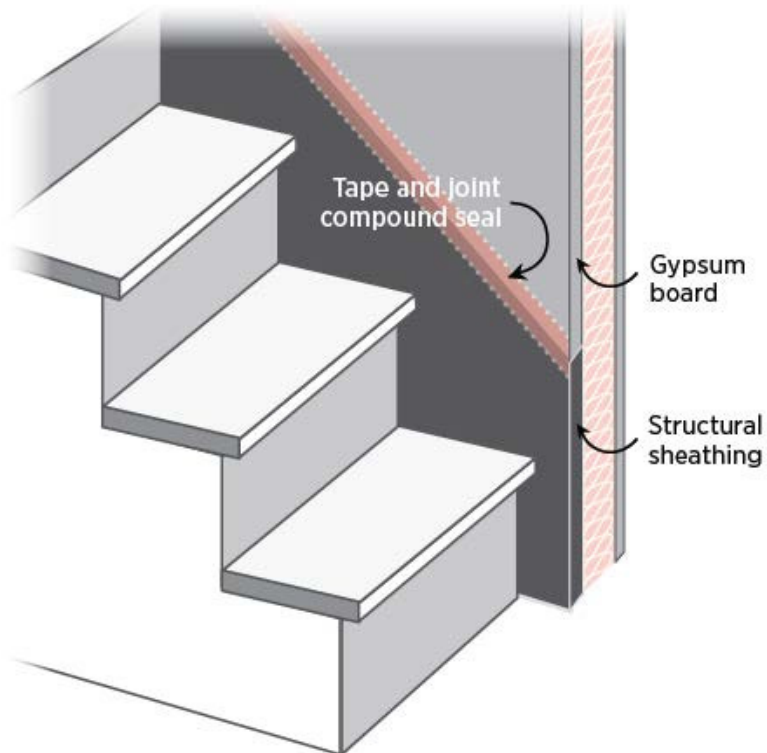

Durability & Health

If warm, moist air gets into a cold attic through leaks in the home's thermal envelope, it can condense on solid surfaces, which may lead to water damage and mold growth.

Above: Install an air barrier and air sealing on exterior walls behind stairs. If the area behind the stairs is inaccessible, caulk the stairs where they meet the wall. Use caulk if the area is already painted; use tape and joint compound if area will be painted.

7. Porch Roof

Air barrier is installed at the intersection of the porch roof and exterior wall.

If a test-in inspection identifies air leakage at the wall separating the porch from the living space, the contractor will investigate to see if the wall board is missing or unsealed. If this is the case, the contractor will install some type of wall sheathing (oriented strand board, plywood, rigid foamboard) cut to fit and sealed at the edges with spray foam. Your contractor will also make sure this wall separating the attic from the porch is fully insulated.

Studies Show

Steven Winter Associates, a Building America research team leader, used a blower door test and infrared cameras to investigate high-energy bill complaints at a 360-unit affordable housing development and found nearly double the expected air leakage. Infrared scanning revealed an air-leakage path on an exterior second-story wall above a front porch. The firm also found that, while the wall between the porch and the attic had been insulated with unfaced fiberglass batts, wall board had never been installed. The insulation was dirty from years of windwashing, as wind carried dust up through the perforated porch ceiling, through the insulation, into the attic, and into the wall above. Crews used rigid foamboard cut to fit and glued it in place with expandable spray foam to seal each area. Blower door tests conducted afterward showed that these improvements reduced overall envelope leakage by 200 CFM50. At a cost of \$267 per unit, this fix resulted in savings of \$200 per year per unit, for a payback in less than two years.

Durability & Health

Cold surfaces in the exterior wall encourage condensation and mold. If the air barrier is missing, wind can carry dust and pollen into the living space.



Above: When researchers pulled back the porch ceiling, they found the wall board was missing, so nothing was covering the insulation on this exterior wall. An air barrier of rigid foamboard was put in place with spray foam.

8. Flue or Chimney Shaft

Opening around flue is closed with flashing, and any remaining gaps are sealed with fire-rated caulk or sealant.

There are often gaps around chimneys, furnaces, and water heater flues that allow conditioned air to flow up into the attic. Your contractor can seal this gap with lightweight aluminum flashing (sheet metal) and special high-temperature (heat-resistant) caulk. A metal dam should be used to keep insulation away from the flue. The same technique is used for masonry chimneys.



Durability & Health

Use the right sealing products and techniques to keep flammable materials from touching hot flues.

- Step 1: Cut aluminum flashing to fit around the flue.
- Step 2: Seal flashing to the pipe with high-temperature caulk.
- Step 3: Form an insulation dam to keep the insulation from coming into contact with the flue pipe.

9. Attic Access/Pull-Down Stairs

Attic access panel or drop-down stairs are fully gasketed for an airtight fit.

A home's attic access, which might be an attic hatch, pull-down stairs, or a kneewall door, can leak a lot of heated and cooled air into the attic if it's not sealed properly.

Your contractor can add weatherstripping either to the frame or the panel of the attic access, and s/he may also install latch bolts to ensure a tighter seal. The hatch lid, stairs or door should be insulated, too. If you're planning to add an attic access, consider the location. An access hatch or pull-down stairs that's located in an unconditioned part of the house, such as a garage, covered patio or porch, does not necessarily need to be air sealed or insulated. If the hatch connects conditioned space, such as a bedroom, hallway or closet, to an unconditioned attic, your contractor will check for air leakage.

Durability & Health

Air sealing the attic access will minimize the amount of moisture-laden air that escapes into the attic, reducing the risk of mold growth in the attic.

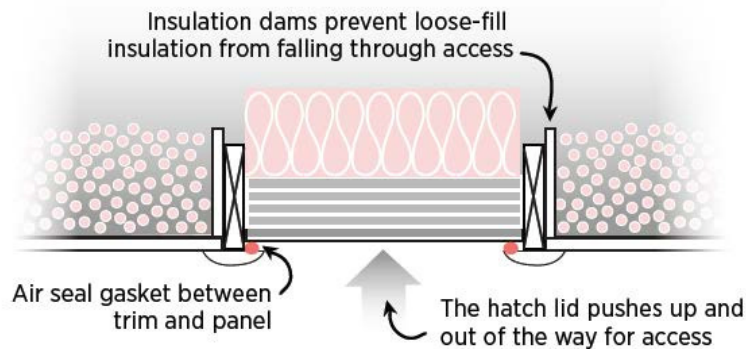

Above: Insulate and air seal the attic access hatch cover.

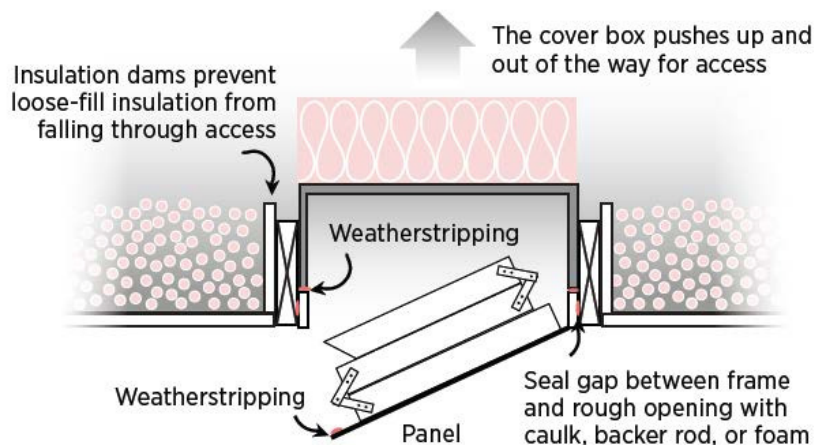

Above: Insulate and air seal the pull-down attic stairs.

10. Recessed Lighting

Fixtures are provided with airtight assembly or covering.

Recessed downlights are the most popular home lighting fixture in the United States. Older model recessed can fixtures are energy-intensive in three ways. First, they are not approved for insulation contact, so insulation has to be kept at least 3 inches away all the way around, leaving about 1 square foot of uninsulated ceiling space. Second, most use incandescent bulbs that use three to five times the power of fluorescents and add to air-conditioning loads. Third, the cans are not airtight, so they allow conditioned air to escape from the living area into unconditioned spaces, such as attics.

If your home has non-airtight fixtures, you can have a contractor replace the whole fixture with insulation contact-rated, airtight (ICAT) fixtures, or caulk around the fixture under the trim ring, if caulking from inside the home. Other alternatives include installing the recessed cans in an air-sealed dropped soffit or using surface-mounted fixtures instead. After air sealing, replace any incandescent lights in the recessed lighting fixture with low-wattage CFL or LED lamps.

Durability & Health

Non-airtight recessed can fixtures can allow heated air to escape to attic during winter, carrying moisture that can condense in a cool attic. They can also draw hot attic air into the home in summer, pulling dust and insulation particles into the home.

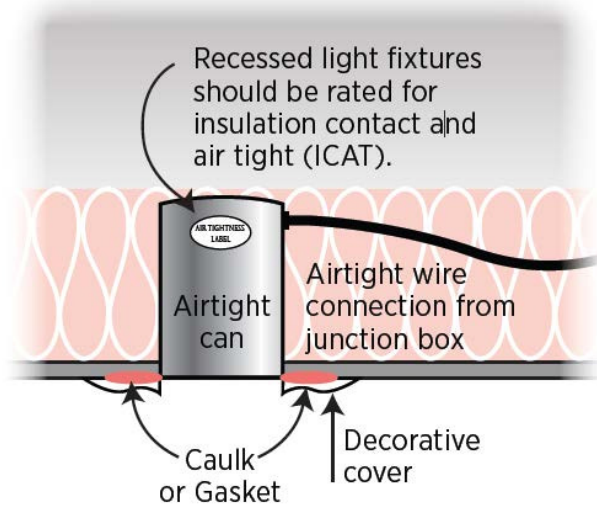

Above: Replace old, leaky can fixtures with insulated, airtight recessed light fixtures, and caulk them where the housing meets the drywall.

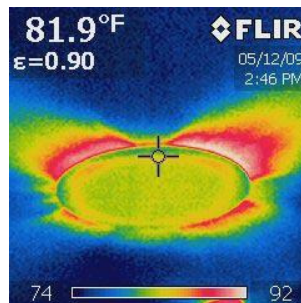

Above: Seal cans to prevent heated and cooled air from leaking into attics, as shown in this infrared camera image.

11. Ducts

All ducts should be sealed, especially in attics, vented crawlspaces, and rim areas.

Repairing leaking ducts can yield big energy improvements. Duct sealing contractors often find more than just a few leaks: duct tape dries and falls away; ducts may have been torn or crumpled by other trades during installation; and poorly hung ducts can have bends and kinks that prevent air from flowing through them. It's not uncommon to find one or more ducts completely disconnected from their register.

If return ducts in the heating and air-conditioning system have holes, they can draw in hot attic air or cold outside air. As a result, the system must work harder and use more energy to heat and cool the inside of the house. In older homes, wall cavities and floor joist cavities are sometimes used as return "ducts" to bring air from the return registers back to the air-handler unit, but these building cavities are rarely air sealed.

A heating and cooling equipment contractor may:

- inspect the duct system, including the attic and crawlspace;
- evaluate the system's supply and return air flow;
- repair damaged and disconnected ducts;
- seal all leaks and connections with mastic (a thick sealant painted on duct joints);
- seal all registers and grilles to the ducts;
- insulate ducts in unconditioned areas (attics, crawlspaces, garages) with duct insulation that has an R-value of 6 or higher;
- replace the filter as part of any duct system improvement;
- re-test air flow after repairs are completed;
- ensure that there is no back-drafting of gas- or oil-burning appliances, and conduct a combustion safety test after ducts are sealed.

Studies Show

In a study of energy-efficient measures, the DOE's Energy Information Administration reported that sealing the ducts yielded, by far, the greatest energy savings of the 12 measures studied, and at the lowest cost (Granade et al., 2009). In a DOE study of 100 homes in Phoenix, Arizona, sealing ducts cut leakage by 30%, saving homeowners \$80 per year. A study of 24 Florida homes found air-conditioning energy use was reduced by 18% after duct repairs were made (Cummings et al., 1990). A study of a retrofit project involving 25 apartments in New York found that sealing the HVAC ducts cut air flow leakage by 92 CFM for supply ducts and 223 CFM for return ducts, with a payback of three to four years (Karins et al., 1997). Research on six homes in the Southwest indicated that 30% to 40% of the thermal energy delivered to the ducts passing through unconditioned spaces is lost through air leakage and conduction through the duct walls. Sealing and insulating the ducts cut overall duct leakage approximately 64% (Jump and Modera, 1994).

Durability & Health

Unsealed ducts can draw in dust, moisture and contamination from unconditioned spaces in the home. Broken ducts can be a pathway for pests.



Above: Paint mastic (a thick, gooey substance) onto the duct seams and joints. (Photo source: Habitat for Humanity, Lakeland, FL)

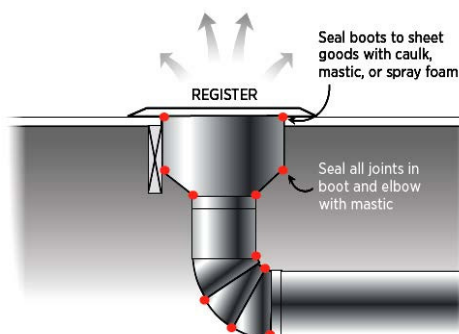

12. Whole-House Fan

Penetration at Attic: An insulated cover is provided that is gasketed or sealed to the opening from either the attic side or ceiling side of the fan.

A whole-house fan is a fan installed in the ceiling to help quickly cool the house by drawing air into the house through open windows on summer mornings and evenings when the outside temperature is lower than the indoor temperature. Ideally, the air should be ducted to exhaust outside, not into the attic space. During the winter months (and in summer when the air conditioner is running), the whole-house fan is not used. At those times, it represents a potential energy loss because it is essentially a large, uninsulated hole in the ceiling. Since standard fan louvers do not insulate or seal tightly, a cover should be constructed or purchased to air seal and insulate this hole from the attic side, the house side, or, in case of very hot or cold weather, both sides. Homeowners must remember to remove cover(s) before operating the fan and to replace cover(s) during seasons when the fan is not in use.

Durability & Health

A whole-house fan can pull large quantities of air from the home and, if windows are not open, it can easily back-draft a fireplace or combustion appliance located in the home or attic. Some localities will not permit a whole-house fan to be installed if a furnace is located in the attic or if there is a combustion appliance in the home that derives its combustion air from either the attic or the inside of the home unless the homeowner 1) encloses the combustion appliance so that it obtains combustion air from outside the home; 2) ducts the whole-house fan directly to the exterior; or 3) provides a switching device that allows only one of the appliances (fan or furnace) to be on at a time (Davis, 2001). The whole-house fan should be ducted to the outside, or adequate ventilation must be provided in the attic to prevent the attic from being over-pressurized and pushing attic dust into the house.

WHOLE-HOUSE FAN

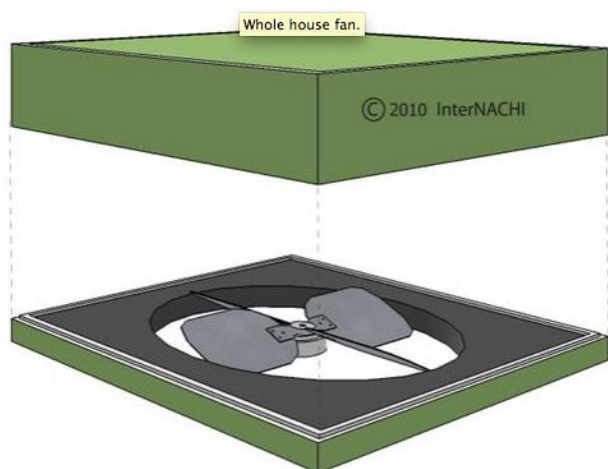

Above: Install a removable, insulating, air sealing cover over your whole-house fan.

13. Exterior Walls

Service penetrations are sealed.

The exterior walls of your home may have a surprising number of holes in them—for plumbing pipes and vents, electrical wires and conduits, electrical fixtures, clothes dryer ducts, and exhaust fans. Holes may also have been drilled through the top and bottom plates; ideally, these were caulked and sealed during construction, as these areas are nearly impossible to access later, unless drywall or exterior sheathing is being replaced. Your contractor will caulk penetrations through walls from the exterior and interior. An ideal time to seal the drywall to the subfloor is when walls are being painted and baseplate trim is removed (just pull back the carpet), or when floor covering is being replaced.

Durability & Health

Unsealed penetrations can be a pathway for dust and pests to enter the home. Penetrations through the top plate must be sealed if the top plate is in the plane of an intended air, smoke or fire separation (BSC, 2009).

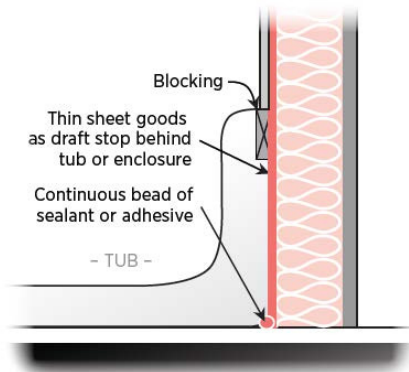
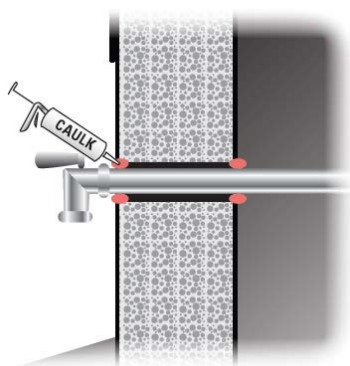

Above left: Caulk all plumbing penetrations through exterior walls.

Above right: If you're remodeling a bathroom, make sure you seal and insulate behind the tub or shower, especially if it's on an exterior wall.

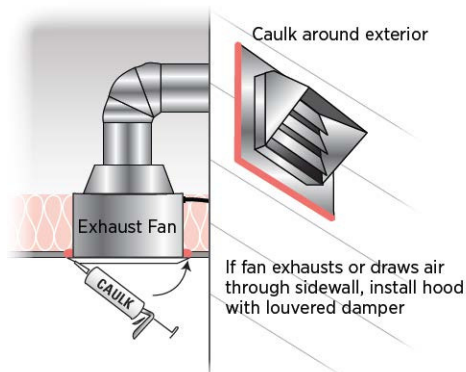
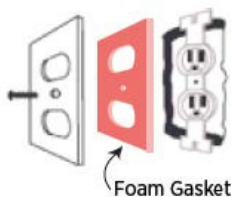
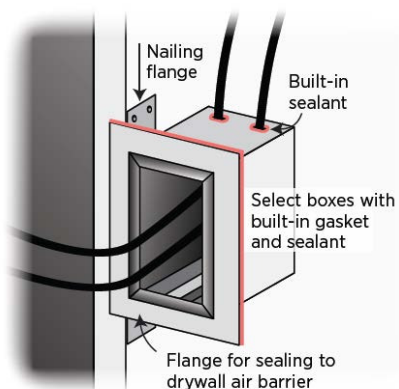

Above left and center: Seal all electrical outlets and switches with foam sealant, or select boxes with built-in sealant or gaskets. Install foam gaskets between electrical outlets or switches and their cover plates, and insert plastic child-safety plugs into the outlets to further block air flow.

Above right: Caulk around exhaust fans at the ceiling and exterior wall. Also, caulk around exterior outlets and light fixtures.

14. Fireplace Wall

Air sealing is completed in framed shaft behind the fireplace or at the fireplace surround.

Fireplaces have many potential areas of air leakage. Air sealing and insulation are often missing from the enclosure that forms a prefabricated fireplace. There are often unsealed air gaps around the flue and the surround. Flue dampers are not airtight, allowing air to escape up the chimney even when no fire is burning in the fireplace (BSC, 2009). A fireplace can actually waste more heat than it creates (Iowa Energy Center, 2008).

Even if you close the fireplace damper and it leaks just a little, a lot of warm air from your home will be drawn up the chimney and be replaced by cold air leaking into the house.

Durability & Health

An open, unsealed fireplace carries the risk of back-drafting carbon monoxide, smoke and ash into the home. A sealed fireplace with its own combustion air intake is preferred. Homes that use gas or wood fireplaces should have carbon-monoxide detectors.

If you use the fireplace, follow these air sealing tips (Iowa Energy Center, 2008):

- Every year, have the fireplace and chimney inspected and cleaned by a certified chimney sweep.
- Check the seal of the flue damper with an incense stick or piece of burning paper. Seal around the damper assembly with refractory cement, but don't seal the damper closed. Replace warped or missing dampers.
- Use a removable plug, such as a chimney balloon, that you insert in the chimney above the damper and inflate it to plug air leaks when you're not using the fireplace. If you forget to remove it before starting a fire, it will react to the heat and quickly deflate.
- Install tight-fitting glass doors.
- To cover the fireplace opening when not in use, make a tight-fitting air barrier from rigid board insulation and plywood edged with pipe insulation (Iowa Energy Center, 2008).
- Consider installing a sealed, natural gas or propane fireplace insert. These inserts are sealed combustion appliances and eliminate the problem of door and flue leaks.

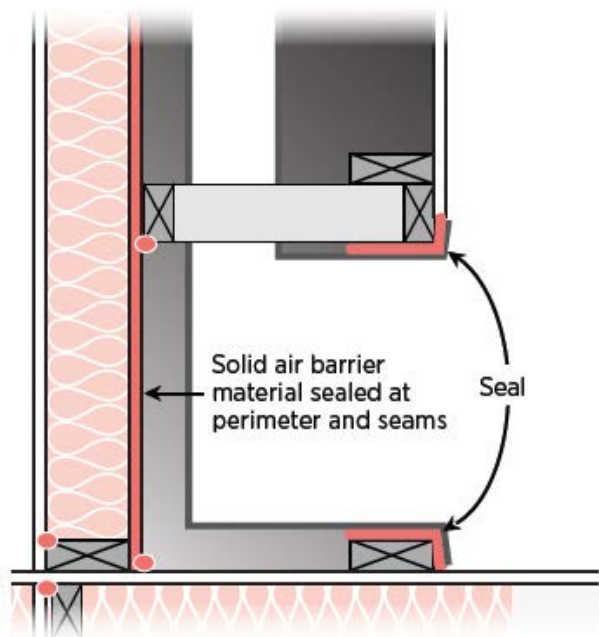

Studies Show

Studies have shown that fireplace dampers are often left open. One study found that 80% of fireplace dampers were inadvertently left open (Tyrol and Pate, 2007). In a DOE-funded study of 56 new homes in Arkansas with gas and wood fireplaces, the fireplaces accounted for 5.3% of total house air leakage (Brown, 1999).

At left: Air seal the enclosure surround and flue.

15. Garage/Living Space Walls

Air sealing is completed between garage and living space. Pass-through door is weatherstripped.

For occupant health and safety, the garage should be completely air sealed from the living areas of the house. When the garage is beneath a second-story living space, the gaps created by the floor joists spanning both the living space and the garage must be blocked off and sealed.

If the air handler for a central furnace must be located in the garage, it should be in an air-sealed closet with its own air intake so that it's not drawing garage air to circulate through the house. If you have an attached garage, expect your contractor to: visually inspect it for cracks and improper sealing of the walls separating the garage from the home; test the seal tightness of doors connecting the garage with the rest of the home; test carbon-monoxide levels in the house; measure interface leakage between the garage and house; and determine what size garage exhaust fan, if any, is advisable.

Durability & Health

Garages often contain harmful chemicals and gases that must be kept out of the living space by thorough air sealing of all common walls and ceilings.

Steps to a Healthier Garage: Eliminate, Isolate & Ventilate

Keep in mind the following:

1. Your very best option is to build a detached garage.
2. If that's not possible, try removing or isolating pollutants. Occasionally park cars, mowers, etc., outside. Do not let cars or mowers idle inside the garage, and, of course, never start them with the garage door closed. Start gas-powered mowers, leaf blowers, etc., outside. Store paints, solvents and other chemicals in tight containers.

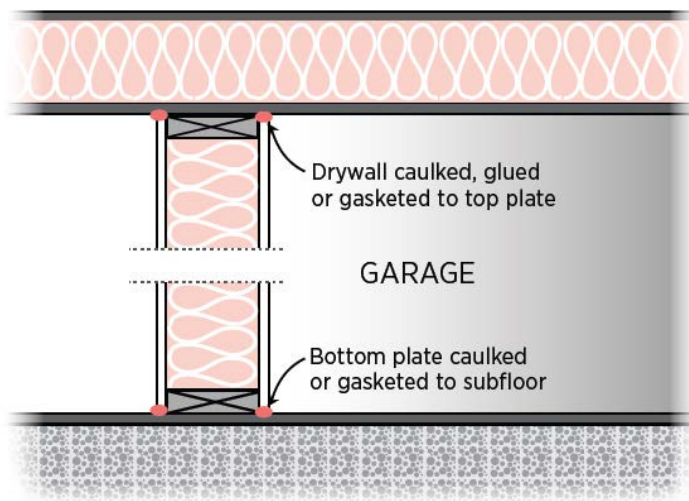

Above right: Finish the walls that separate the garage from the rest of the home with drywall that's sealed to the top and bottom plate with a bead of caulk.

Your contractor can assist you with the following recommendations:

1. Seal all penetrations through the common wall and ceiling. Use gaskets, airtight drywall techniques, etc., to make the common wall and ceiling airtight.
2. Seal ducts located in the garage. (When remodeling, avoid installing supply or return registers in the garage.)
3. Install a self-closing, insulated, fire-rated metal door (with a good weather seal) between the living space and the garage.
4. Install a passive roof vent to keep the garage at a negative pressure in relation to the house. If needed, install a timed exhaust fan that vents to the outside.

16. Cantilevered Floor

Cantilevered floors are air sealed and insulated at perimeter or joist transitions.

Cantilevered floors, second-story bump-outs, and bay windows are other areas in the home that often lack proper air sealing.

The floor cavity must be filled with insulation with good alignment (i.e., completely touching) the underside of the floor. The interior and exterior sheathing needs to be sealed at the framing edges. Blocking between floor joists should form a consistent air barrier between the cantilever and the rest of the house. Continuous sheathing, such as insulating foam sheathing, should cover the underside of the cantilever and be air sealed at the edges with caulk.

Durability & Health

If a cantilever isn't properly air sealed and insulated, moist air from the home can pass into the cantilever floor cavity and condense on the coldest surface it finds—the backside of the sheathing or band joist—causing mold to grow there.

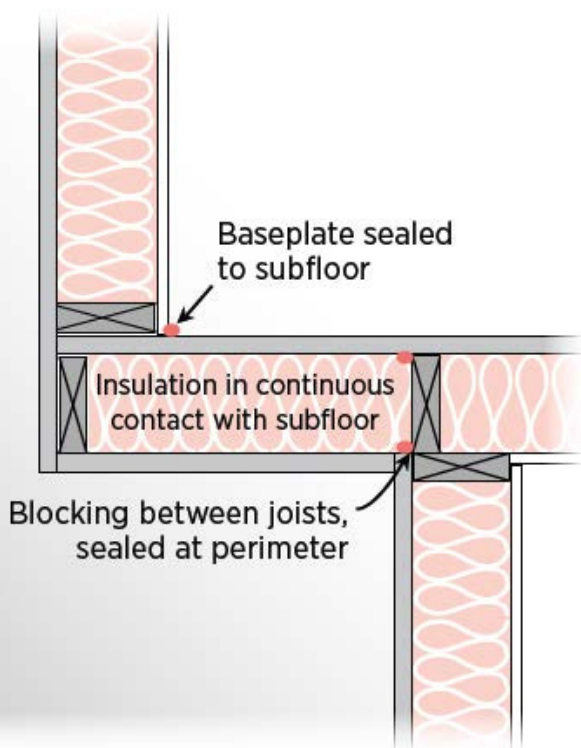

Above: Block and air seal the junctions where the floor meets the upper wall and where the floor meets the lower wall.

17. Rim Joists, Sill Plate, Foundation and Floor

Rim joists are insulated and include an air barrier. Junction of foundation and sill plate is sealed. Penetrations through the bottom plate are sealed. All leaks at foundations, floor joists and floor penetrations are sealed. Exposed earth in crawlspace is covered with Class I vapor retarder overlapped and taped at seams.

The rim joist (also called a band joist) is the horizontal beam that rests on top of the foundation wall and between floors. The floor joists are attached to or run parallel with it. Rim joists are a particularly troublesome area for air leakage. Several framing components (including the foundation wall and sill plate or top plate, rim joist, and subfloor above) need to be connected and sealed to form a continuous air barrier. Your contractor will inspect this area and, if needed, air seal and insulate along the joints where the floor joists meet the rim joist and where the rim joist meets the subfloor. The rim joist can be air sealed and insulated with caulk and batt insulation or rigid foamboard cut to fill the space between each floor joist, and then sealed in place with spray foam. Another option is to spray high- or low-density urethane foam at each joist bay to cover the foundation connections at the wall, top plate, rim joist and subfloor.

Durability & Health

The interior side of the rim joist is a cold surface in wintertime. Condensation can form there if it's not properly insulated. A crawlspace's dirt floor should be covered with a Class 1 vapor retarder, such as 6-mil polyethylene. If the home has an unvented crawlspace, the underside of the floor should be air sealed, and a vent stack can be installed to minimize the entry of soil gases into the living space.

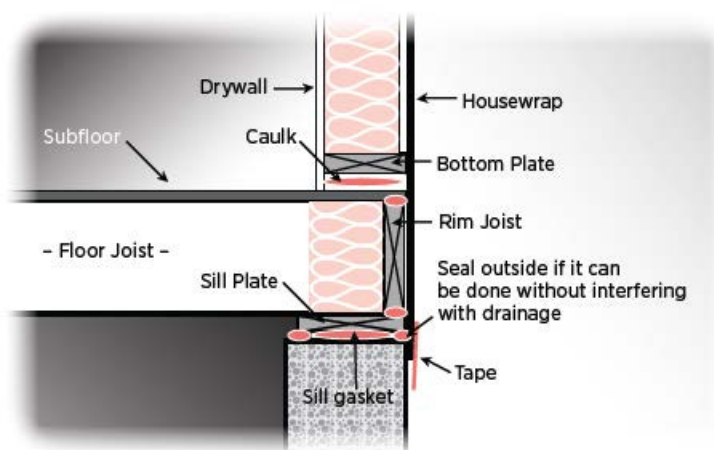

Above: Use caulk or spray foam to air seal where the foundation wall meets the sill plate, where the sill plate meets the rim joist, and where the rim joist meets the subfloor.

Your contractor will seal the seams of the subfloor plywood panels if they are accessible. The contractor will also seal all holes that go through the basement ceiling to the floor above, such as holes for plumbing, HVAC ducts, and furnace vent pipes if the furnace is located in the basement. If your house's foundation is a slab type, your contractor can check for and seal air leaks where the sill plate meets the foundation. If your home has an unvented crawlspace, your contractor will check the foundation for cracks and holes that may need sealing. The crawlspace access hatch should be weatherstripped or gasketed. If the crawlspace floor has exposed earth, this should be covered with a Class I vapor retarder, with overlapping joints that are taped.



Above: Spray foam along the basement rim joist to provide a complete air barrier connecting the foundation wall, sill plate, rim joist and subfloor (Source: BSC, 2009).

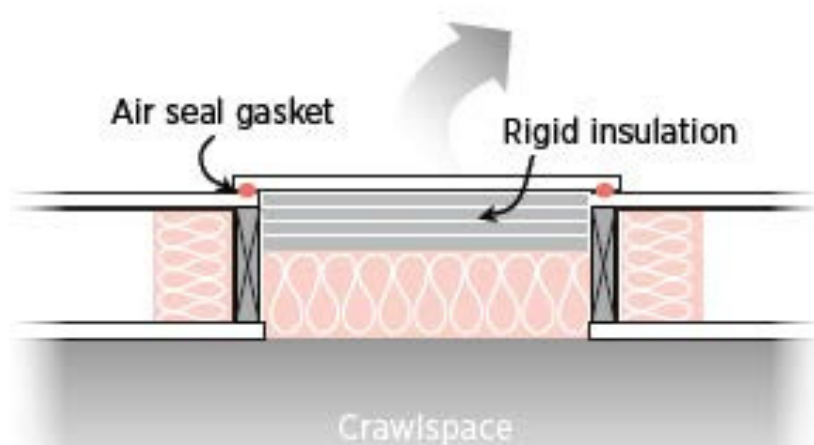

Above: Air seal the crawlspace access hatch by installing a gasket or weatherstripping around the hatch edges.

Studies Show

One homeowner in Illinois had spent thousands of dollars re-siding his house with rigid foamboard insulation, adding insulation, upgrading his furnace, and replacing windows, but his house was still drafty and his utility bills were still high. He called in a BPI-certified contractor who conducted several assessments, including a blower door test of the whole house and individual rooms to determine where air was leaking. The blower door showed that the home's air leakage was three times higher than preferred. The contractor recommended: plugging leaks in the crawlspace and rim joists; adding joist insulation; air sealing all plumbing, electrical, service, and duct penetrations; and insulating and air sealing the crawlspace access and attic hatch cover. The upgrades cost \$2,500 and saved the homeowner \$700 a year in energy costs (Conbere and Fried, 2006).

18. Windows and Doors

Space between window/door jambs and framing is sealed.

When windows are installed in a new house, the rough opening (the space left for the window) is typically made 1.5 to 2 inches larger than the window frame to give the installer room to install, plumb and square the window. The same is true of doors. Your contractor can properly seal around the existing windows by removing the interior trim and filling the rough opening with non-expanding foam or backer rod and caulk. A simpler but more visible alternative is to leave the interior trim in place and seal around it with a clear silicone caulk or paintable latex caulk with silicone. Replace any cracked or loose panes. Consider replacing older, single-pane windows that show signs of leakage, water damage, or condensation with new double-pane windows installed with proper air sealing and flashing.

Durability & Health

More efficient windows may be less prone to condensation and related mold growth.

Painted window sashes and frames in homes built before 1978 may contain lead-based paint, so use a contractor experienced in lead-paint removal.

Windows and doors should be weatherstripped. Visit the DOE Energy Savers website for a comprehensive description of the different types of caulking and weatherstripping material available: www.energysavers.gov/your_home/insulation_airsealing/index.cfm/mytopic=11260.

Older homes often have double-hung windows with chases hidden in the wall for counterweights. Access these chases by removing the side trim or by going through access ports along the sides of the window. If the window is replaced, the counterweight should be removed and the chases filled with insulation and sealed. If you have old windows with working pulleys, the pulley holes can be air sealed but kept usable with plastic caps called pulley seals. Doors should be self-closing and have a tight-fitting sill.

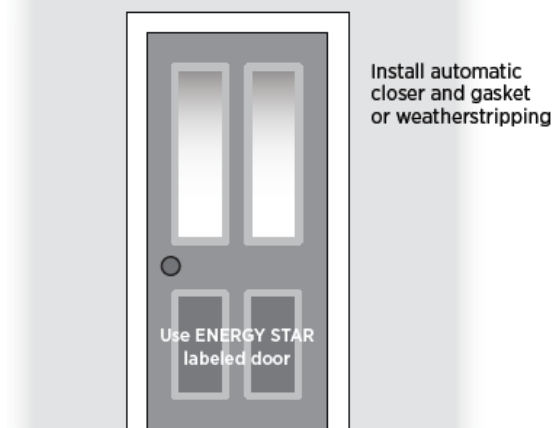
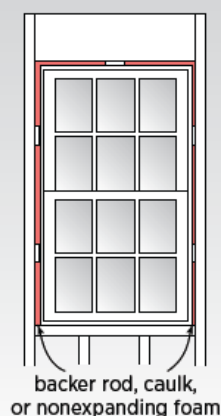

Above left: Use backer rod, caulk, or non-expanding foam approved for windows and doors to fill the rough-in gap around doors and windows (DOE, 2000).

Above right: Install automatic closer and gasket or weatherstripping around doors. Caulk around trim.

19. Common Walls Between Attached Dwelling Units

The gap between a gypsum shaft wall (i.e., common wall) and the structural framing between units is sealed.

Common walls between units in multi-family housing (such as townhouses, duplexes and apartments) should be constructed as airtight assemblies for sound, smoke, fire, and air-quality control. However, experience has shown that these common walls can often be significant sources of air and heat loss if gaps or cracks exist in the connections between each unit's walls. Your contractor can determine whether this is a significant source of air leakage in your home.

To reduce air leakage, this assembly should be air sealed at all boundaries. Your contractor will seal wood frame walls with fireproof spray foam (EPA, 2008). Masonry block party walls, which form "chimneys" because of their porosity and open cores, can be air sealed with two-component urethane foam, which also reduces sound, odor transfer, and dust, insects, and moisture entry (Braun et al., 1995).

Because these walls are fire-rated assemblies for each unit, acceptable materials for air sealing common walls can vary significantly around the country. Your contractor will confirm with local code officials which material is preferred for fire safety prior to retrofitting. The contractor will seal all plumbing penetrations through the drywall surface of common walls with fire-rated sealant materials (BSC, 2009).

Durability & Health

Common walls between units are fire-rated and should be air sealed and properly blocked to minimize fire spread and entry of air, moisture and pests.



*Above: Seal air gaps between two framed common walls.
(Source: Energy Services Group via the EPA, 2008)*

Homeowner Tips: Insulation and Sealing Air Leaks

Checking your home's insulation is one of the fastest and most cost-effective ways to use a whole-house approach to reduce energy waste and make the most of your energy dollars. A good insulating system includes a combination of products and construction techniques that protect a home from outside hot and cold temperatures, protect it against air leaks, and control moisture. You can increase the comfort of your home while reducing your heating and cooling needs by investing in proper insulation and sealing air leaks.



Should I insulate my home?

Insulate your home when:

- you have an older home and haven't added insulation. Only 20% of homes built before 1980 are adequately insulated;
- you are uncomfortably cold in the winter or hot in the summer. Adding insulation creates a more uniform temperature and increases comfort;
- you build a new home or addition, or install new siding or roofing;
- you pay too much for your energy bills; or
- you're bothered by noise from outside. Insulation muffles sound.

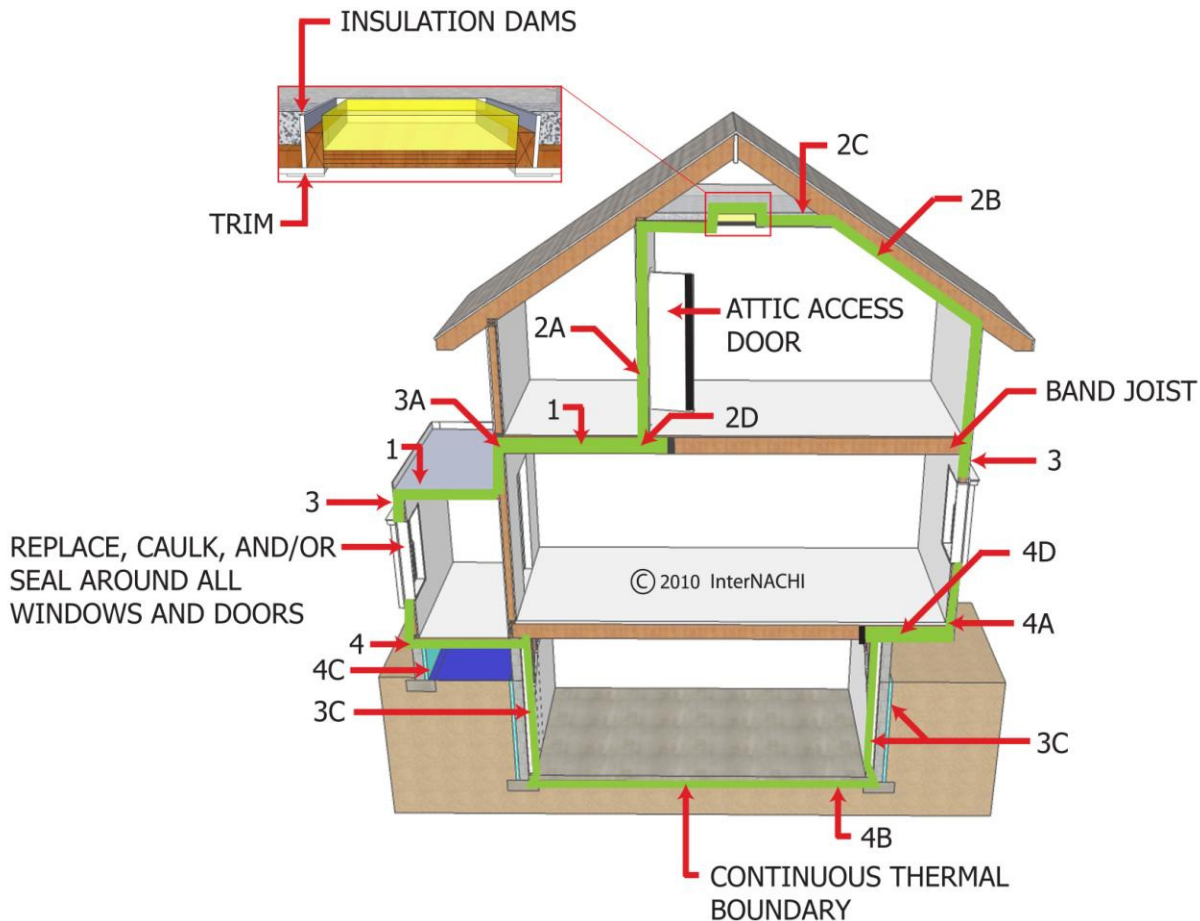

1. In unfinished attic spaces, insulate between and over floor joists to seal off living spaces below.
2. In finished attic rooms with or without dormers:
 - 2A. insulate between studs of kneewalls;
 - 2B. insulate between studs and rafters of exterior walls and the roof;
 - 2C. insulate ceilings with cold space above; and
 - 2D. extend insulation into joist spaces to reduce air flow.
3. Insulate at exterior walls, such as:
 - 3A. walls between living spaces and unheated garages, shed roofs, and storage areas;
 - 3B. foundation walls above ground; and
 - 3C. foundation walls in heated basements.
4. Insulate above cold spaces, vented crawlspaces, and unheated garages. Also:
 - 4A. insulate any portion of the floor in a room that cantilevers beyond an exterior wall;
 - 4B. insulate slab floors built directly on the ground;
 - 4C. insulate foundation walls of unvented crawlspaces; and
 - 4D. extend insulation into joist spaces to reduce air flow.

Adding Insulation

Adding insulation in the areas shown on the previous page may be the best way to improve your home's energy efficiency. Insulate either the attic floor or under the roof. Check with a contractor about crawlspace and basement insulation.

R-Values

First, check the insulation in your attic, ceilings, exterior and basement walls, floors, and crawlspace to see if it meets the levels recommended for your area. Insulation is measured in R-values—the higher the R-value, the better your walls and roof will resist the transfer of heat. The DOE recommends ranges of R-values based on local heating and cooling costs, as well as climate conditions in different areas of the country.

The map below and its corresponding chart on the following page show the DOE's recommendations for your area. The minimum insulation requirements according to the codes for your particular state and locality may be less than the DOE's recommendations, which are based on cost-effectiveness.

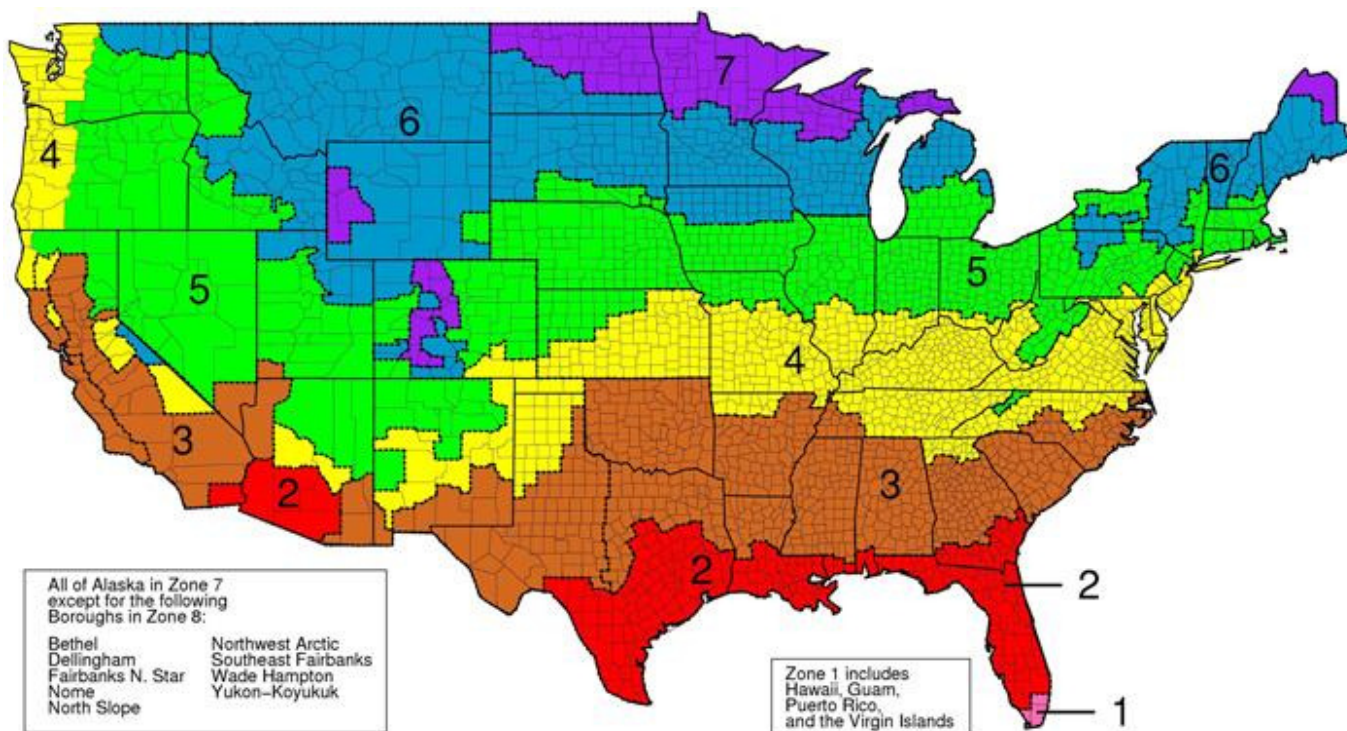

Zone	Gas	Heat Pump	Fuel Oil	Electric Furnace	Attic	Cathedral Ceiling	Wall		Floor
							Cavity	Insulation Sheathing	
1	X	X	X	X	R30-R49	R22-R38	R13-R15	None	R13
2	X	X	X		R30-R60	R22-R38	R13-R15	None	R13
2				X	R30-R60	R22-R38	R13-R15	None	R19-R25
3	X	X	X		R30-R60	R22-R38	R13-R15	None	R25
3				X	R30-R60	R22-R38	R13-R15	R2.5-R5	R25
4	X	X	X		R38-R60	R30-R38	R13-R15	R2.5-R6	R25-R30
4				X	R38-R60	R30-R38	R13-R15	R5-R6	R25-R30
5	X	X	X		R38-R60	R30-R38	R13-R15	R2.5-R6	R25-R30
5				X	R38-R60	R30-R60	R13-R21	R5-R6	R25-R30
6	X	X	X	X	R49-R60	R30-R60	R13-R21	R5-R6	R25-R30
7	X	X	X	X	R49-R60	R30-R60	R13-R21	R5-R6	R25-R30
8	X	X	X	X	R49-R60	R30-R60	R13-R21	R5-R6	R25-R30

Although insulation can be made from a variety of materials, it usually comes in four types, and each type has different characteristics.



Rolls and batts or blankets are flexible products made from mineral fibers, such as fiberglass and rock wool. They're available in widths suited to standard spacings of wall studs and attic and floor joists: 2x4 walls can hold R-13 or R-15 batts; 2x6 walls can use R-19 or R-21 products.

Loose-fill insulation is usually made of fiberglass, rock wool, or cellulose in the form of loose fibers or fiber pellets. It should be blown into spaces using special pneumatic equipment. The blown-in material conforms readily to building cavities and attics. Therefore, loose-fill insulation is well-suited to places where it's difficult to install other types of insulation.

Rigid foam or foamboard insulation is typically more expensive than fiber insulation, but it's very effective in buildings with space limitations and where higher R-values are needed. Foam insulation R-values range from R-4 to R-6.5 per inch of thickness, which is up to two times greater than most other insulating materials of the same thickness.

Foam-in-place insulation can be blown into walls. It reduces air leakage if it's blown into cracks, such as around window and door frames.

Quick Tips: Insulation

- Consider factors such as your climate, building design and budget when selecting insulation R-values for your home.
- Use higher-density insulation, such as rigid foamboard, on exterior walls, in cathedral ceilings, and on exterior walls.
- Ventilation helps with moisture control and for reducing summer cooling bills. Attic vents can be installed along the entire ceiling cavity, from the soffit to the attic, to help ensure proper air flow to make a home more comfortable and energy-efficient. Do not ventilate your attic if you have insulation on the underside of the roof. Check with a qualified contractor.
- Recessed light fixtures can be a major source of heat loss, but you need to be careful of how close you place insulation next to a fixture unless it's marked "IC," which means it's designed for direct insulation contact. Check your local building codes for recommendations. Review Section 10 on Recessed Lighting (page 18) for more information about recessed can lights.
- Follow the product instructions as specified on the product packaging for guidelines on proper installation, and be sure to wear the proper protective gear when installing insulation.

Insulation: Long-Term Savings Tip

One of the most cost-effective ways to make your home more comfortable year-round is to add insulation to your attic.

Adding insulation to the attic is relatively easy. To find out if you have enough before adding more, measure the thickness of the insulation that's currently installed. If it's less than R-30 (11 inches of fiberglass or rock wool, or 8 inches of cellulose), you could probably benefit by adding more. Most U.S. homes should have between R-30 and R-60 insulation in the attic. Don't forget the attic trap or access door.

If your attic has enough insulation and your home still feels drafty and cold in the winter or too warm in the summer, chances are you need to add insulation to the exterior walls, as well. This is a more expensive measure that usually requires a contractor, but it may be worth the cost if you live in a very hot or cold climate. If you replace the exterior siding on your home, you should consider adding insulation at the same time.

You may also need to add insulation to your crawlspace or basement. Check with a professional contractor.

Quick Tips: Sealing Air Leaks

Warm air leaking into your home during the summer and out of your home during the winter can waste a lot of your energy dollars. One of the quickest dollar-saving tasks you can perform is caulk, seal and weatherstrip all seams, cracks and openings to the outside. You can save on your heating and cooling bills by reducing these air leaks in your home.

How Does the Air Escape?

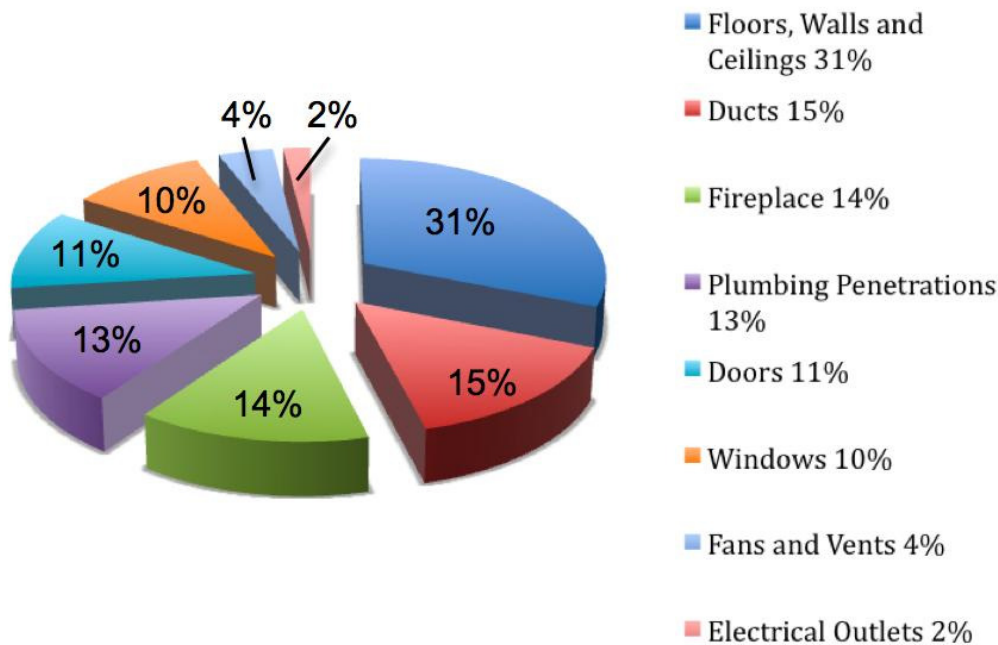

Tips for Sealing Air Leaks

Air infiltrates into and out of your home through every hole and crack. About one-third of this air infiltrates through openings in your ceilings, walls and floors. Here are some measures you can take yourself.

- First, test your home for air-tightness. On a windy day, carefully hold a lit incense stick or a smoke pen next to your windows, doors, electrical boxes, plumbing fixtures, electrical outlets, ceiling fixtures, attic hatches, and other locations where there is a possible air path to the outside. If the smoke stream travels horizontally, you have located an air leak that may need caulking, sealing or weatherstripping.
- Caulk and weatherstrip doors and windows that leak air.
- Caulk and seal air leaks where plumbing, ducting or electrical wiring penetrates through walls, floors, ceilings, and soffits located over cabinets.
- Install foam gaskets behind outlet and switch plates on walls.
- Look for dirty spots in your insulation, which often indicate holes where air leaks into and out of your house. You can seal the holes with low-expansion spray foam made for this purpose.
- Look for dirty spots on your ceiling paint and carpet, which may indicate air leaks at interior wall-ceiling joints and wall-floor joints. These joints can be caulked.
- Install storm windows over single-pane windows, or replace them with more efficient windows, such as double-pane. (See Section 18: Windows and Doors, page 27, for more information.)

- When the fireplace is not in use, keep the flue damper tightly closed. A chimney is designed specifically for smoke to escape, so until you close it, warm air escapes—24 hours a day!
- For new construction, reduce exterior wall leaks by installing housewrap, taping the joints of exterior sheathing, and caulking and sealing all the exterior walls.
- Use foam sealant for larger gaps around windows, baseboards, and other places where warm air may be leaking out.
- Kitchen exhaust fan covers can keep air from leaking in when the exhaust fan is not in use. The covers typically attach via magnets for ease of replacement.
- Replacing existing door bottoms and thresholds with ones that have pliable sealing gaskets is a great way to prevent conditioned air from leaking out underneath exterior doors.
- Fireplace flues are made from metal and, over time, repeated heating and cooling can cause the metal to warp or break, creating a channel for hot or cold air loss. Inflatable chimney balloons are designed to fit beneath your fireplace flue during periods of non-use. They're made from several layers of durable plastic and can be removed easily and reused hundreds of times. Should you forget to remove the balloon before making a fire, the balloon will automatically deflate within seconds of coming into contact with heat.

Sources of Air Leaks in Your Home

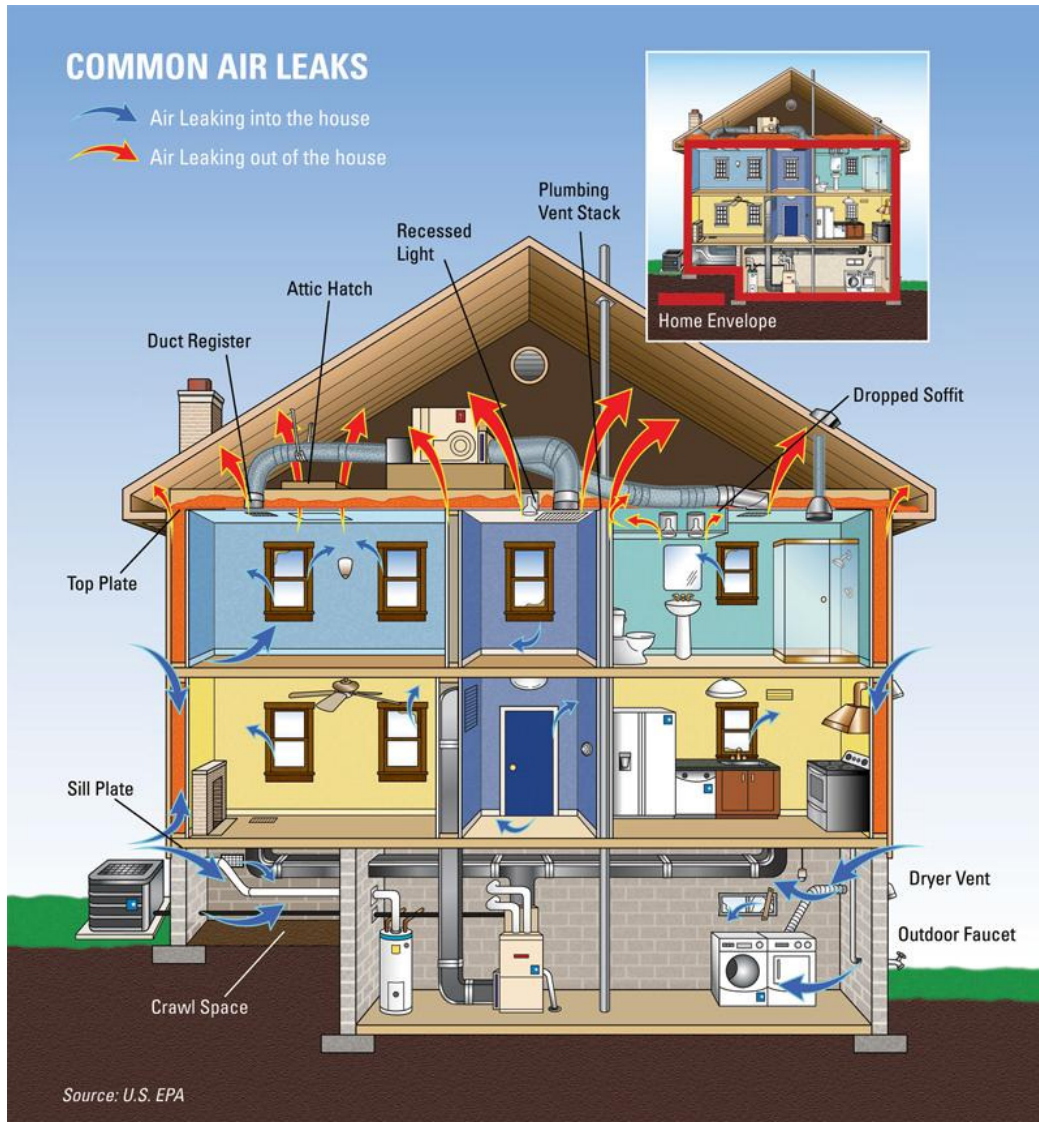

Areas that leak air into and out of your home cost you lots of money. Check the areas listed below:

- Dropped ceilings
- Recessed light fixtures
- Attic entrance
- Sill plates
- Water and furnace flues
- All ducts
- Door frames
- Chimney flashing
- Window frames
- Electrical outlets and switches
- Plumbing and utility accesses